

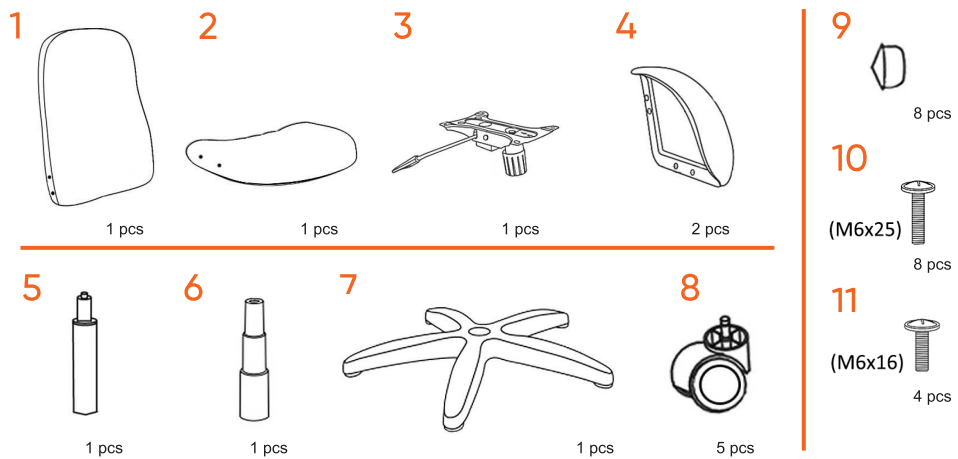

# Chairman 279

**RU** ИНСТРУКЦИЯ ПО СБОРКЕ  
**EN** ASSEMBLY INSTRUCTIONS  
**DE** AUFBAUANLEITUNG  
**FR** INSTRUCTIONS DE MONTAGE  
**IT** MANUALE D'USO  
**ES** INSTRUCCIONES DE MONTAJE  
**CS** NÁVOD K MONTÁŽI  
**KK** ЖИНАУ ЖӨНІНДЕГІ НҰСҚАУЛЫҚ



**STEP 1**  
↓  
**STEP 2**

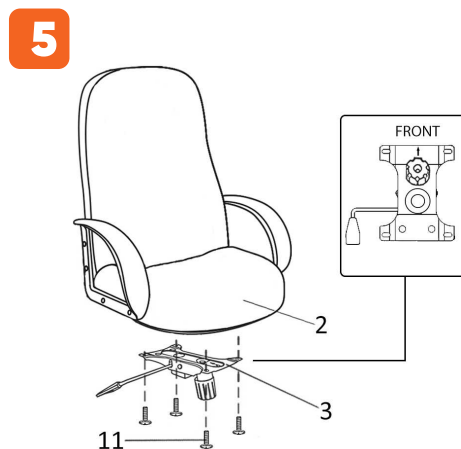
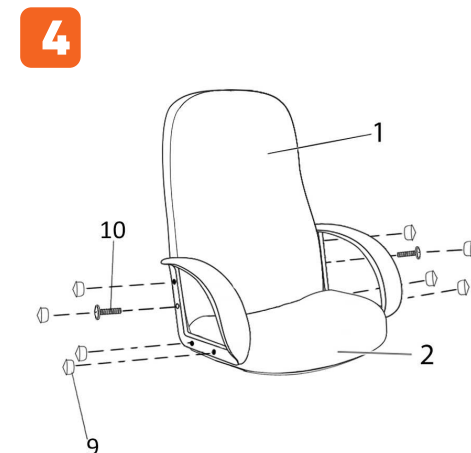
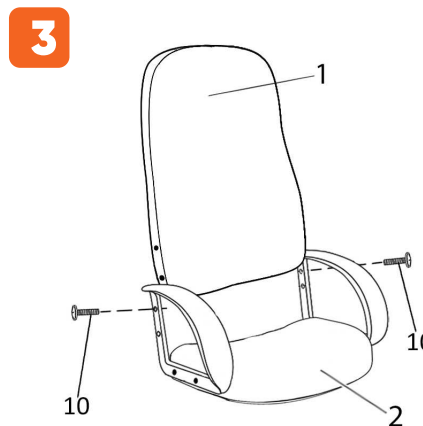
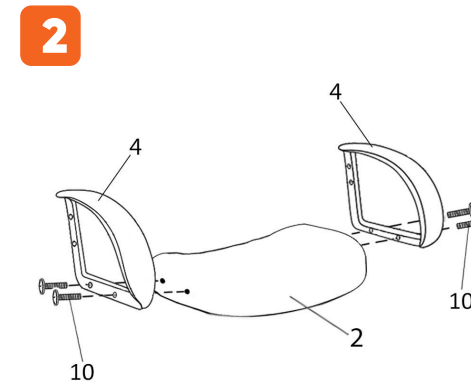
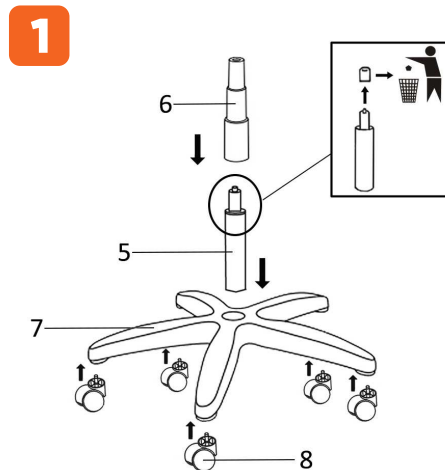

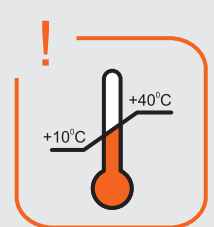
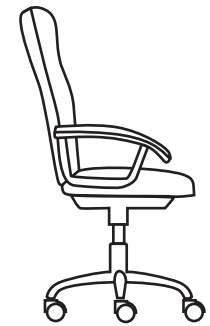
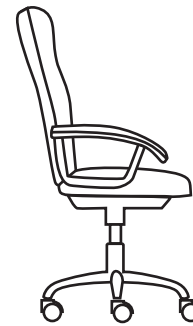
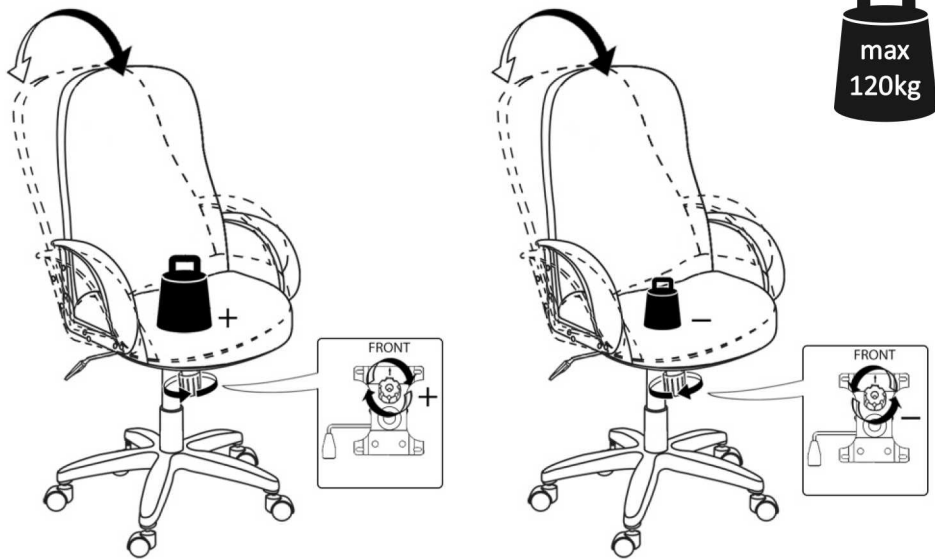
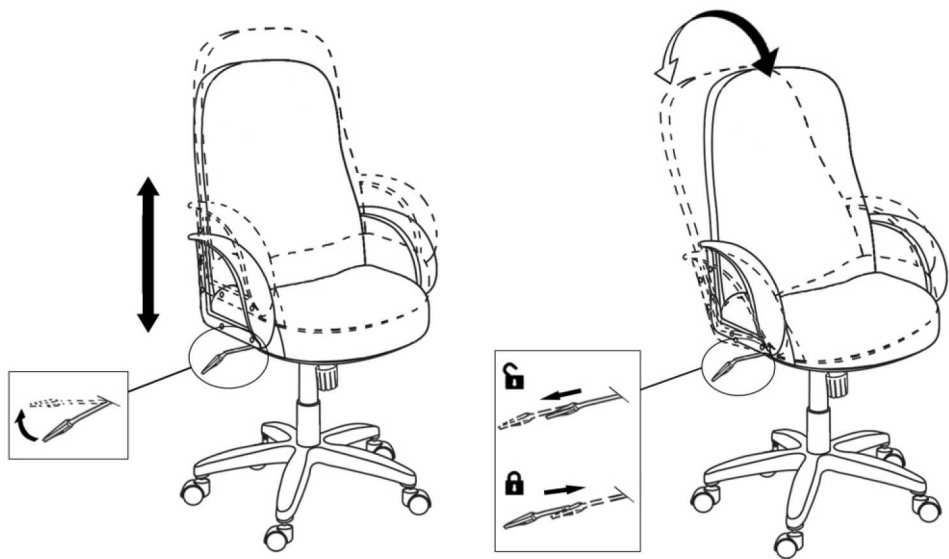

**CHAIRMAN**  
ПОМОГАЕТ РАБОТАТЬ

- chairman.ru
- info@chairman.ru
- instagram.com/chairman\_chairs
- vk.com/chairman\_chairs
- @chairs.chairman